



NexGO[®] DX KIT



UNIVERSAL SMARTPHONE ADAPTER AND Bluetooth[®] REMOTE

#81038

ENGLISH

Instruction Manual

Thank you for purchasing the NexGO DX Kit Universal Smartphone Adapter and Bluetooth[®] Remote. NexGO is a great first step into the world of digiscoping or astroimaging. This easy-to-use adapter will help you capture sharp, detailed images and video through your optic's eyepiece.

What's in the Box



NexGO Smartphone Adapter



Quick Setup Guides



Bluetooth[®] Remote



Phone Booster

Unfolding NexGO

The NexGO ships in the folded position. To use it, you'll first need to unfold NexGO and lock the clamp into the main body.

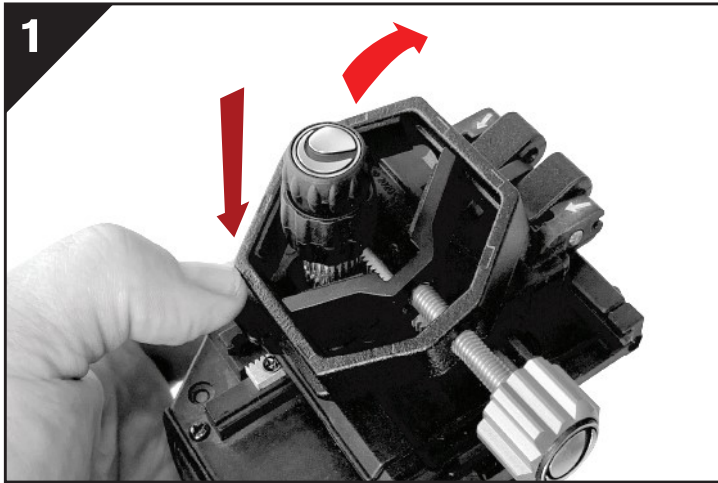

Press the lock tab to release the clamp.



Flip the clamp open.

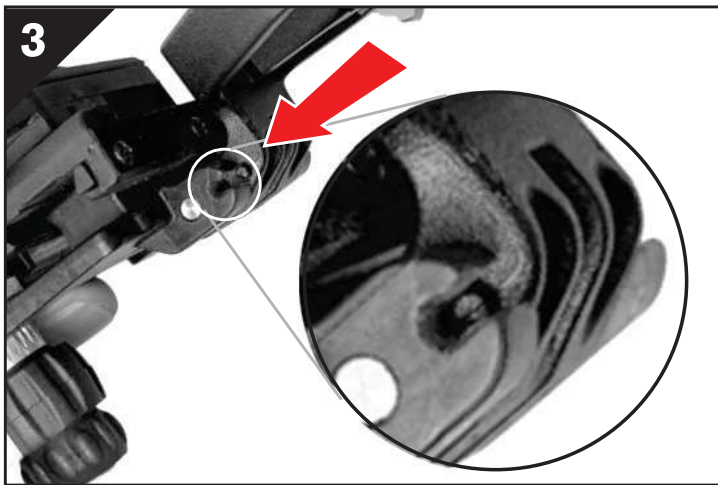

Align the tab on the clamp with the “C”-shaped opening on the phone bed assembly. Once aligned, push the clamp in towards the bed assembly, locking the clamp in place. You should feel a slight “click” when the clamp engages properly.

YOU ARE NOW READY TO USE YOUR NexGO!

Attaching NexGO To Your Optic

NexGO is designed to work with many different optics, including telescopes, binoculars, spotting scopes, and even microscopes. All these optics have different size eyepieces. NexGO's clamp range can open from 25.4mm (1.0") to 44.45mm (1.75") to accommodate a variety of eyepieces.

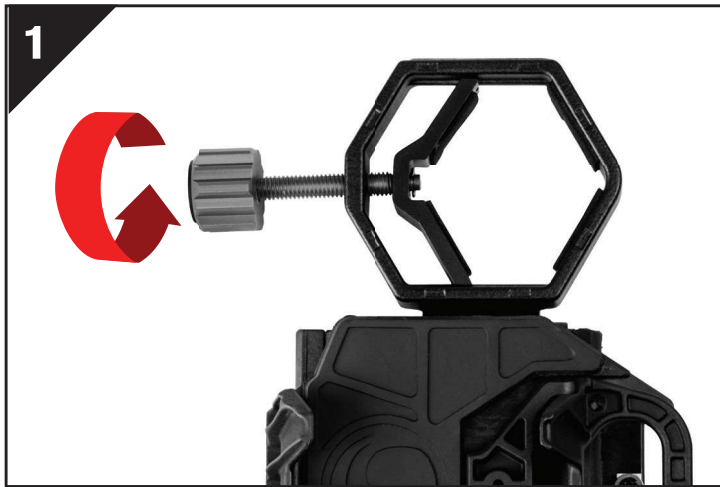

To attach NexGO to your eyepiece, first open the clamp (if needed) by rotating the clamp knob.



Then position the clamp over your eyepiece.

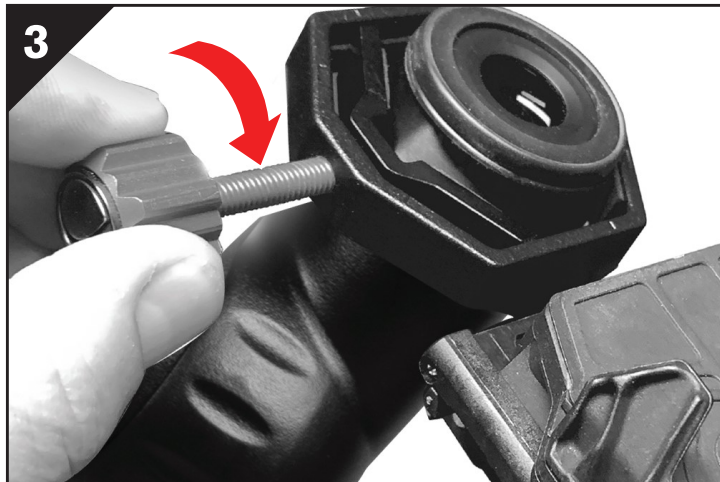

Tighten the clamp and assembly onto the eyepiece by rotating the clamp knob clockwise.

Securing Your Phone on the Phone Bed

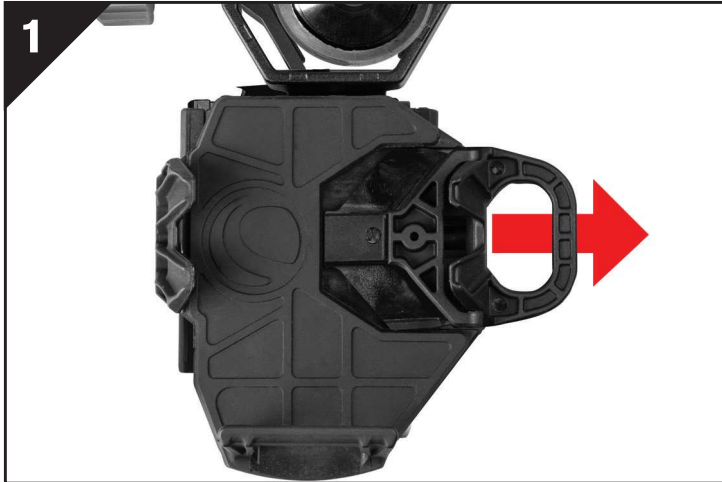

1 Pull the spring-loaded arm on the phone bed outward.

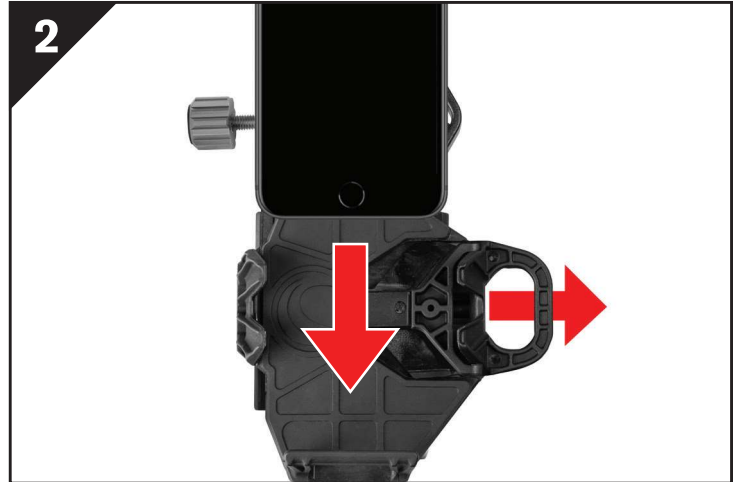

2 While holding the arm open, place your phone on the bed. Make sure the phone is resting flat on the bed.



3 Slowly release the spring loaded arm to secure the phone in place.

NOTE:

We have included a booster to raise up smaller phones that measure less than 5" in length. If you need to use the booster, place it in the phone bed first, and then place your phone on top of the booster.

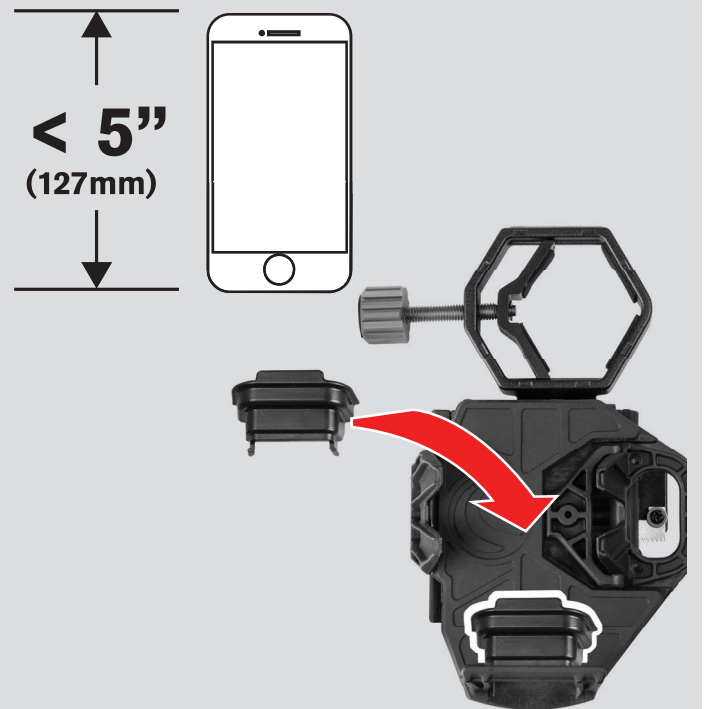

Aligning Your Smartphone Camera

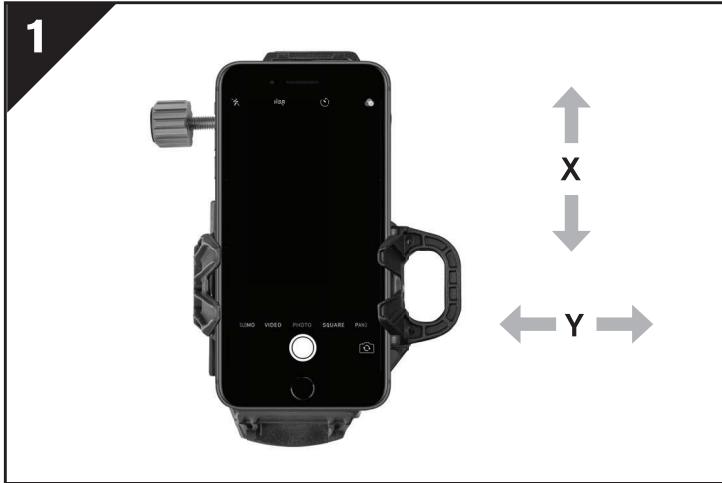

Turn on your smartphone camera.

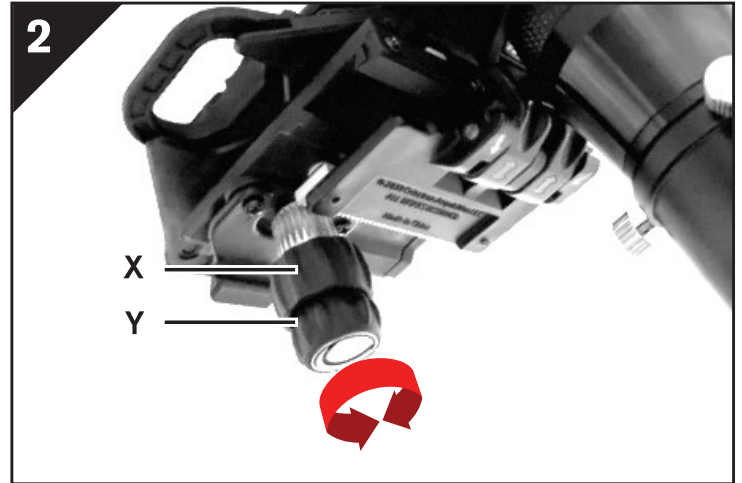

Use the X and Y adjustment knobs to move your phone and adjust the field of view until it is centered over the eyepiece.



NOTE: You may need to zoom in slightly to remove any dark edges or “vignetting.”

You are now ready to shoot great images through your optics!

Folding NexGO for Storage

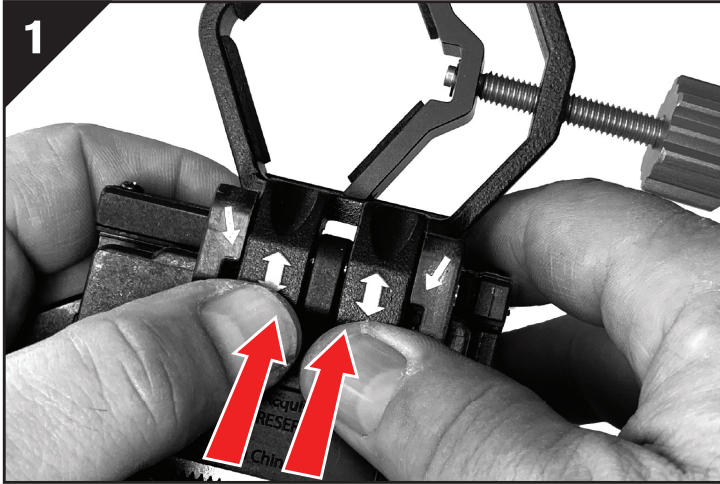

On the underside of the unit, you will see two white arrows. Use both thumbs to push out and disengage the clamp from the main assembly.

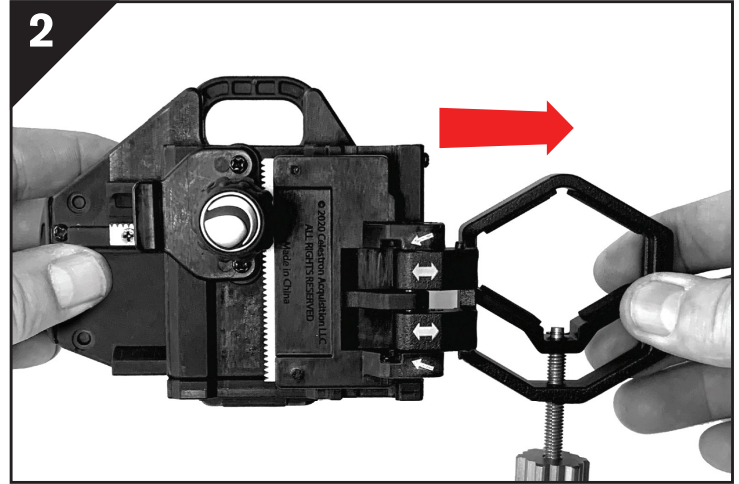

Make sure the clamp is all the way out.

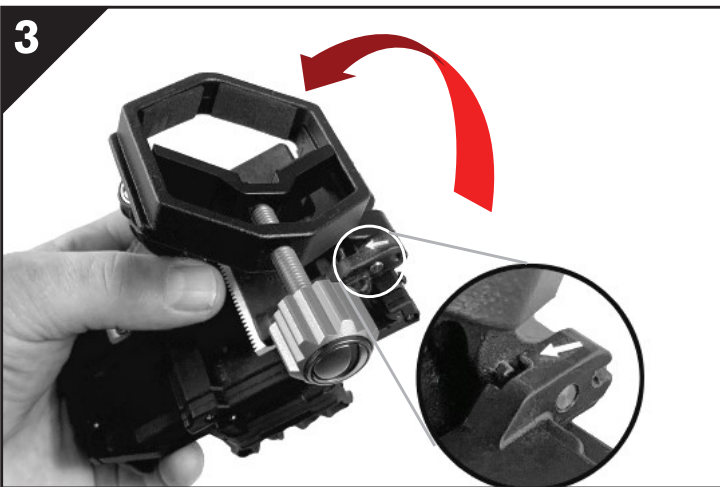

Hinge the clamp back and align the tabs on the clamp with the openings on the main assembly as shown.

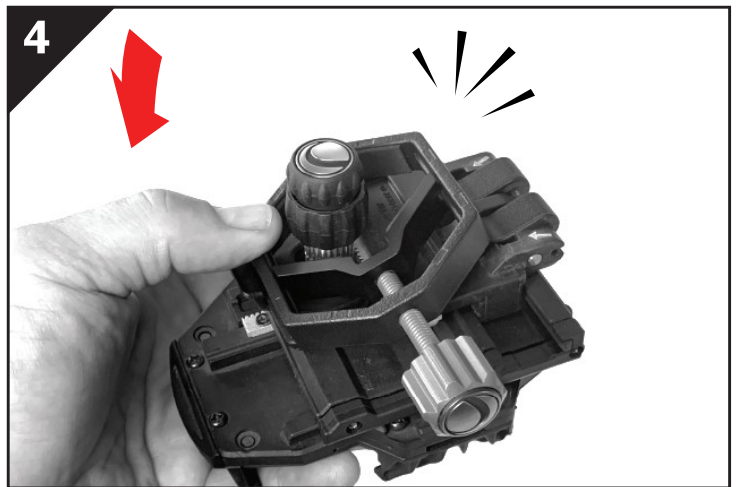

Slide the clamp into place and press until it snaps into place with the lock tab.

SAFETY INSTRUCTIONS

- There is a risk of explosion if the battery is replaced with an incorrect type.
- The included battery is not rechargeable.
- Only use the battery as originally intended to avoid a short circuit. Connecting the conductive material directly to the battery's positive and negative sides will cause a short circuit.
- Do not use a damaged battery.
- Do not store the battery in an extremely cold or hot environment. Doing so can reduce battery life.
- Remove batteries if drained or if product is to be left unused for a long time.
- When replacing the battery, refer to the instruction manual and ensure the positive and negative sides are oriented correctly.
- Do not put the battery in fire.
- Dispose of the battery according to local regulations.

FCC IDENTIFIER: 2A2FG-93974

NOTE: FCC certification is for the Bluetooth Remote Control included with this product. Model # 93974

This device complies with Part 15 of the FCC Rules. Operation is subject to the following two conditions: (1) This device may not cause harmful interference, and (2) this device must accept any interference received, including interference that may cause undesired operation.

CAUTION: Changes or modifications not expressly approved by the party responsible for compliance could void the user's authority to operate the equipment.

NOTE: This equipment has been tested and found to comply with the limits for a Class B digital device, pursuant to part 15 of the FCC Rules. These limits are designed to provide reasonable protection against harmful interference in a residential installation.

This equipment generates, uses and can radiate radio frequency energy and, if not installed and used in accordance with the instructions, may cause harmful interference to radio communications. However, there is no guarantee that interference will not occur in a particular installation.

If this equipment does cause harmful interference to radio or television reception, which can be determined by turning the equipment off and on, the user is encouraged to try to correct the interference by one or more of the following measures:

- Reorient or relocate the receiving antenna.
- Increase the separation between the equipment and receiver.
- Connect the equipment into an outlet on a circuit different from that to which the receiver is connected.
- Consult the dealer or an experienced radio/TV technician for help.



SOLAR WARNING: Never attempt to view the sun through any telescope.



celestron.com/pages/warranty

NEED ASSISTANCE? Contact Celestron Technical Support

celestron.com/pages/technical-support

Product design and specifications are subject to change without prior notification. This product is designed and intended for use by those 14 years of age and older.



©2024 Celestron. Celestron and Symbol are trademarks of Celestron, LLC.

All rights reserved. ▪ Celestron.com

US: Celestron, 2835 Columbia Street, Torrance, CA 90503 USA

UK: Celestron Global Ltd., Unit 2 Transigo, Gables Way, Thatcham RG19 4JZ, United Kingdom

Made in China | 09-24

BATTERY WARNING	
 	<ul style="list-style-type: none"> • INGESTION HAZARD: This product contains a button cell or coin battery. • DEATH or serious injury can occur if ingested. • A swallowed button cell or coin battery can cause Internal Chemical Burns in as little as 2 hours. • KEEP new and used batteries OUT OF REACH OF CHILDREN • SEEK IMMEDIATE MEDICAL ATTENTION if a battery is suspected to be swallowed or inserted inside any part of the body.

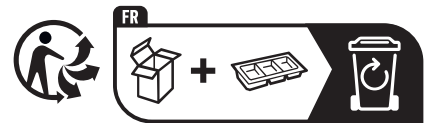

Points de collecte sur www.quefairedemesdechets.fr
Privilégiez la réparation ou le don de votre appareil !



Separate waste collection. Check your local municipal guidelines.

Raccolta differenziata. Verifica le disposizioni del tuo Comune.

